

# Quickstart guide

NDB40  
DAB radio

**N|I|K|K|E|I**



- EN For more information see [www.nikkei.eu](http://www.nikkei.eu)
- NL Voor meer informatie zie [www.nikkei.eu](http://www.nikkei.eu)
- DE Für weitere Informationen siehe [www.nikkei.eu](http://www.nikkei.eu)
- FR Pour plus d'informations, veuillez consulter le site [www.nikkei.eu](http://www.nikkei.eu)
- ES Para más información, visite [www.nikkei.eu](http://www.nikkei.eu)
- DK For mere information besøg [www.nikkei.eu](http://www.nikkei.eu)
- FI Lisätietoja löydät osoitteesta [www.nikkei.eu](http://www.nikkei.eu)



**1**

## Check the contents

Controleer de inhoud  
Kontrollieren Sie den Inhalt  
Vérifiez le contenu  
Revise el contenido  
Kontroller indholdet  
Tarkista sisältö

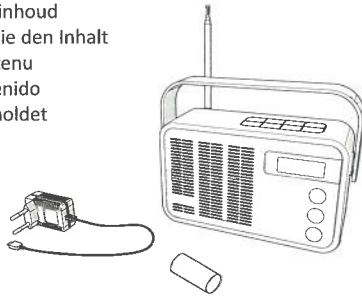

**2**

## The buttons

De knoppen Die Tasten Les boutons  
Los botones Knapperne Painikkeet

1	INFO/MODE	9	VOL +
2	ALARM	10	VOL -
3	PRESET	11	POWER
4	SELECT	12	MICRO SD
5	MODE	13	USB
6	SCAN	14	AUX
7	PREV	15	DC 5V IN
8	NEXT	16	HEAD PHONE

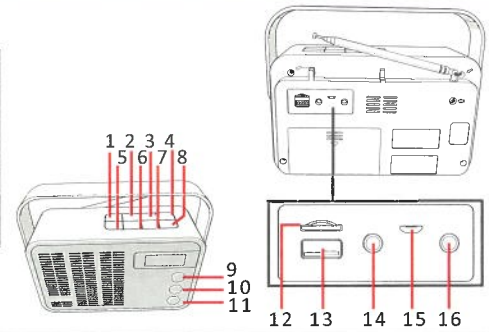

**3**

## Insert the batteries/connect to the mains

Plaats de batterijen / Sluit op het lichtnet aan  
Legen Sie die Batterien ein / Schließen Sie Netzspannung an  
Placez les piles / Raccordez au réseau électrique  
Coloque las pilas / Conecte a la red eléctrica  
Sæt batteriet i / Tilslut til lysnettet  
Paristojen asettaminen / Kytke verkkovirtaan

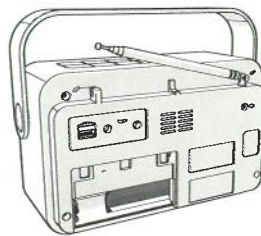

OR

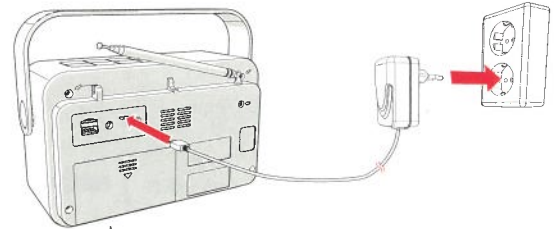

**4**

## Turn the radio ON

Zet de radio aan  
Radio einschalten  
Allumez la radio  
Encender la radio  
Tænd for radioen  
Kytke radioen virta

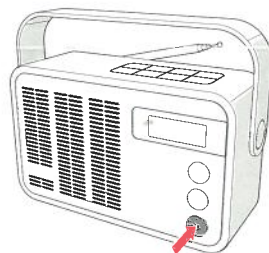

**5**

## The Mode Button

De Mode knop  
Mode-Taste  
Bouton Mode  
Bouton Mode  
Mode-knappen  
Mode-painike

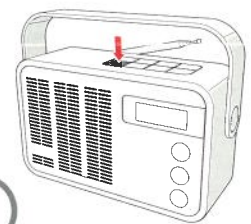

**6**

## Save a radiostation into the memory

Radiozender opslaan in het geheugen  
Radiosender im Speicher speichern  
Enregistrer la station de radio dans la mémoire  
Guardar una emisora de radio en la memoria  
Radiosender gemmes i hukommelsen  
Tallenna asema muistiin

MAX. 10

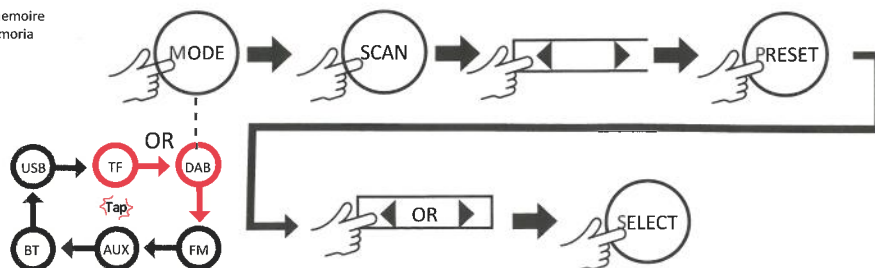

# 8

## Setting the alarm

Het alarm instellen  
 Wecker einstellen  
 Régler l'alarme  
 Ajustar despertador  
 Alarmen indstilles  
 Herätyksen säätö

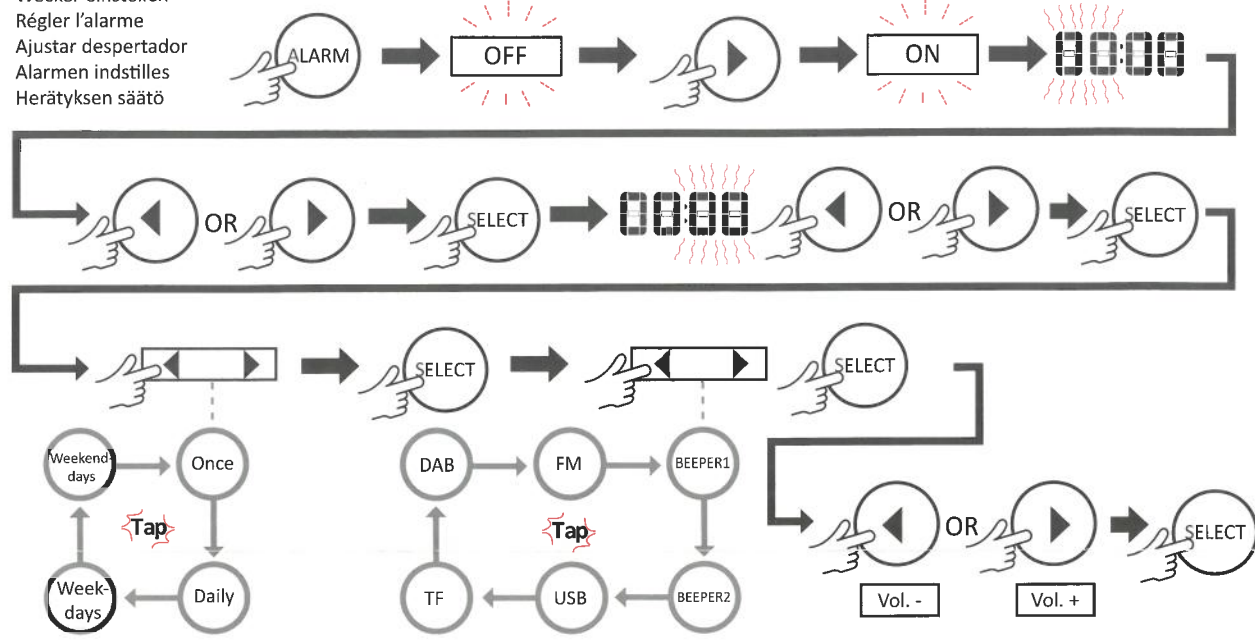

# 9

## Setting the alarm On

Het alarm aan- of uitzetten  
 Wecker ein- oder ausschalten  
 Mettre en/hors service l'alarme  
 Activar/desactivar despertador  
 Alarmen slås til eller fra  
 Herätyksen kyt kentä päälle/pois



# 10

## Switching the alarm Off or Snooze

Het alarm uitzetten of uitstellen  
 Wecker abstellen oder ausschalten  
 Débrancher ou postposer l'alarme  
 Apagar o posponer el despertador  
 Alarmen slås til eller slås fra  
 Herätyksen kuittaus tai torkkku



# 11

## Bluetooth connection

Bluetooth-verbinding  
 Bluetooth Verbindung  
 Connexion Bluetooth  
 Conexión Bluetooth  
 Bluetooth-forbindelse  
 Bluetooth-yhteyks

See [www.nikkei.eu](http://www.nikkei.eu)

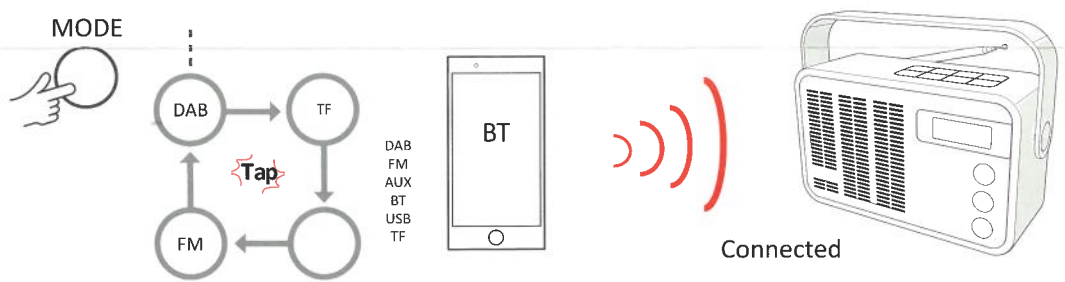

Specifications	Specificaties	Technische Daten	Spécifications	Especificaciones	Specifikationer	Tekniset tiedot
Power supply: AC 220V-240V ~ 50 Hz LCD Display Earphone jack Alarm clock DAB+ / FM Radio Weight: 732 g Dimensions: 210x130x80 mm Warranty: 24 months	Stroomvoeding: AC 220V-240V ~ 50 Hz LCD display Hoofdtelefoonaansluiting Alarmlok DAB+ / FM Radio Gewicht: 732 g Afmetingen: 210x130x80 mm Garantie: 24 maanden	Stromzufuhr: AC 220V-240V ~ 50 Hz LCD-Display Kopfhörerbuchse Wecker DAB+ / FM Radio Gewicht: 732 g Abmessungen: 210x130x80 mm Garantie: 24 Monate	Alimentation électrique: AC 220V-240V ~ 50 Hz Affichage LCD Prise casque Horloge alarme DAB+ / FM Radio Poids: 732 g Dimensions: 210x130x80 mm Garantie: 24 mois	Fuente de alimentación: AC 220V-240V ~ 50 Hz Pantalla LCD Toma de auriculares Reloj alarma DAB+ / FM Radio Peso: 732 g Dimensiones: 210x130x80 mm Garantía: 24 meses	Strømforsyning: AC 220V-240V ~ 50 Hz LCD-display Hovedtelefonstik Alarumur DAB+ / FM Radio Vægt: 732 g Dimensioner: 210x130x80 mm Garanti: 24 måned	Syöttövirta: AC 220V-240V ~ 50 Hz Lcdnäyttö Kuulokkeen liitin Herätyskello DAB+ / FM Radio Paino: 732 g Mitat: 210x130x80 mm Takuu: 24 kuukautta